



YANMAR

MARINE PRODUCT HANDBOOK

COMMERCIAL HIGH SPEED DIESEL ENGINES

78 mhp [57.4 kW] to 1822 mhp [1340 kW]

Head Office

Yanmar Co., Ltd.
YANMAR FLYING-Y BUILDING,
1-32 Chayamachi, Kita-ku,
530-8311 Osaka, Japan,
www.yanmar.com

Regional Office / Sales & Service

Yanmar Europe B.V.
Brugplein 11, 1332 BS Almere, The Netherlands
T +31 (0)36 549 3200
F +31 (0)36 549 3209
www.yanmar.eu

www.yanmarmarine.eu

Call for Yanmar solutions

EN-CHISMPH-0115



**Reliability,
Economical efficiency
& Comfort
for customers
dedicated to
maritime activity.**

Our pride is to contribute to tough and valuable activities of customers on the sea.

Harmony with the Environment — IMO Emission Limits —

The pollution of the atmosphere by hazardous substances released from marine diesel engines has become a major global issue. The release of hazardous substances into the atmosphere by ships is regulated by the International Convention for the Prevention of Pollution from Ships (MARPOL 73/78). Annex VI: Prevention of Air Pollution from Ships was later passed in September 1997. As a result, the regulation of NOx emission levels began for marine diesel engines with a power of above 130kW on vessels built on or after January 1,2000. A further amendment was passed in October, 2008 and engines mounted in vessels built on or after January 1,2011 face even stricter Tier II regulations. Technological solutions have been developed to overcome these regulatory challenges including engine technologies, supplementary technologies and post processing technologies. YANMAR is addressing the stricter IMO Tier II regulation NOx limits with improvements to combustion technologies of engine.

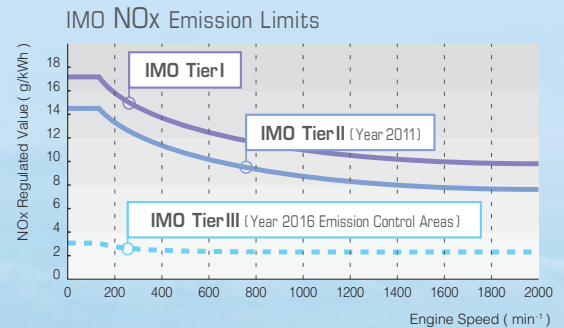

Global Hub Factory
for Marine Diesel Engines

Marine Operations Division

The YANMAR Marine Operations Division specializes in developing and producing small and medium-sized diesel engines mainly at the Tsukaguchi Plant. From processing of components for marine propulsion engines, marine auxiliary engines, land and industrial engines to assembly, rigging, and test runs, the Tsukaguchi Plant uses a consistent quality control system to produce a wide range of diesel engines. We deliver highly reliable products that thoroughly apply the technologies and expertise that we have fine-tuned over the years to markets in Japan and all over the world.



Assembly Process [Cell]



Tsukaguchi Plant

Certified by the six major classification societies.

The Tsukaguchi Plant has been certified by world's six most authoritative shipping classification societies, LRS(Lloyd's Register of Shipping), ABS(American Bureau of Shipping), NK(Nippon Kaiji Kyokai), BV(Bureau Veritas), RINA(Registro Italiano Navale) and KR(Korea Register of Shipping).



Certifications of 6 major shipping classification societies

- LRS** [Lloyd's Register of Shipping]
- ABS** [American Bureau of Shipping]
- NK** [Nippon Kaiji Kyokai]
- BV** [Bureau Veritas]
- RINA** [Registro Italiano Navale]
- KR** [Korean Register of Shipping]

The Certifications of shipping classification societies vary with the model of engine. For more information, please contact us.

MARINE PROPULSION DIESEL ENGINE

Rating definitions:

hp=0.735kW Ratings are based on conditions of 100kPa, 30% relative humidity at 25°C.

S = For applications where use of rated power is less than 30 minutes continuous out of every 90 minutes and operation is less than 1000 hours per year.

When combined with a correctly matched propeller which allows the engine rated rpm to be achieved in a fully loaded vessel state, the reduced-power operation can be at or below 50-100 rpm of the rated speed.

L = For applications where use of rated power is less than 2 hours continuous out of every 5 hours and operation is less than 2000 hours per year.

When combined with a correctly matched propeller which allows the engine rated rpm to be achieved in a fully loaded vessel state, the reduced-power operation can be at or below 50-100 rpm of the rated speed.

M = For applications where use of rated power is less than 10 hours continuous out of every 16 hours and operation is less than 3000 hours per year.

When combined with a correctly matched propeller which allows the engine rated rpm to be achieved in a fully loaded vessel state, the reduced-power operation can be at or below 50-100 rpm of the rated speed.

H = For applications where use of rated power is less than 24hours continuous out of every 30 hours and operation is less than 4000 hours per year.

When combined with a correctly matched propeller which allows the engine rated rpm to be achieved in a fully loaded vessel state, the reduced-power operation can be at or below 50-100 rpm of the rated speed.

* Please ask Yanmar or local distributor for the detail of each model.
Fuel rates: Specific gravity 0.835g/cc, low calorific value 42700kJ/kg (10200kcal/kg), Cetane No.45.

Note : All Data Subject to Change Without Notice.
Photograph may show optional equipment.

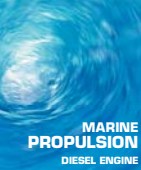

4CHE3 / 6CHE3

M · L-rating 57.4~95.6kW (78~130mhp)

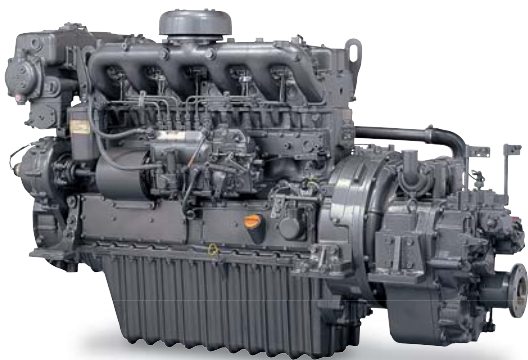

- Direct injection, heat exchanger cooling.
- Natural aspirated 4- and 6-cylinder.
- Durable hydraulic marine gear.

Specifications

Model	4CHE3	6CHE3	
Number of cylinders	4 in-line	6 in-line	
Bore × stroke	mm 105 × 125		
Displacement	lit. 4.330	6.494	
Rated output	kW(hp)/rpm	M : 57.4(78)/2550	M : 84.6(115)/2550
		L : 62.5(85)/2600	L : 95.6(130)/2600
Combustion system	Direct injection		
Aspiration	Natural aspirated		
Starting system	Electric starting motor (24V 4.0kW)		
Cooling system	Heat exchanger		
Marine gear	Hydraulic		
Size of flywheel housing and flywheel	SAE #3 and 11-1/2 in.		
Dry mass (with marine gear)	kg 570	700	
Dimensions (L × W × H)	mm 1258 × 688 × 1022 with YX30	1496 × 690 × 1018 with YX30	

Marine gear specifications

Engine model : 4CHE3 · 6CHE3	
Model	YX-30
Type	Hydraulic multi-disc clutch, wet type
Reduction ratio (Ahead)	2.03 2.55 2.96 3.48
Direction of rotation (propeller shaft)	Clockwise or counter-clockwise viewed from stern
Dry weight	kg 70

Dimensions Unit:mm

Engine only / Front view

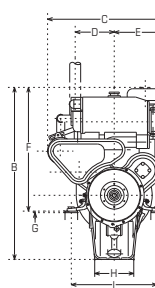

Engine only / Left side view

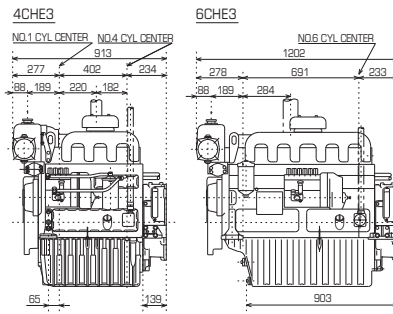

With gearbox / Rear view

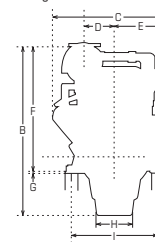

With gearbox / Left side view

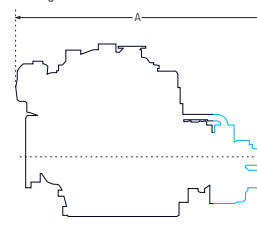

Model	A	B	C	D	E	F	G	H	I
4CHE3 × YX-30-2	1258	1022	688	232	292	735	9	232	510
6CHE3 × YX-30-2	1496	1018	690	233	300	737	9	233	550

— Marine gear

Performance curves

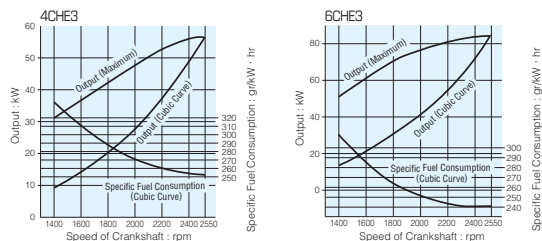

6CH-HTE3 / WUTE

M · L-rating 125~206kW (170~280mhp)

MARINE
PROPULSION
DIESEL ENGINE

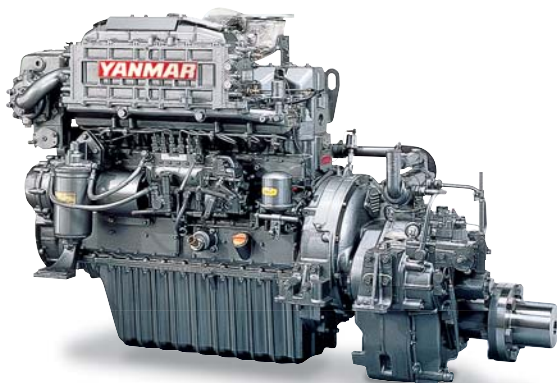

- Direct injection, heat exchanger cooling.
- Turbocharger + intercooler.
- Durable hydraulic marine gear.
- 6CH-WUTE conform to IMO Tier II emissions regulations.

Specifications

Model	6CH-HTE3	6CH-WUTE
Number of cylinders	6 in-line	
Bore × stroke	mm 105 × 125	
Displacement	lit. 6.494	
Rated output	kW(hp)/rpm	M : 125(170)/2550 L : 140(190)/2600
		M : 188(255)/2550 L : 206(280)/2600
Combustion system	Direct injection	
Aspiration	Turbocharger + intercooler	
Starting system	Electric starting motor (24V 4.0kW)	
Cooling system	Heat exchanger	
Marine gear	Hydraulic	
Size of flywheel housing and flywheel	SAE #3 and 11-1/2 in.	
Dry mass (with marine gear)	kg 895	940
Dimensions (L × W × H)	mm 1575 × 736 × 1096	1600 × 736 × 1111

Marine gear specifications

Engine model : 6CH-HTE3, 6CH-WUTE	
Model	YX-71
Type	Hydraulic multi-disc clutch, wet type
Reduction ratio (Ahead)	2.07 2.58 2.91 3.53
Direction of rotation (propeller shaft)	Clockwise or counter-clockwise viewed from stern
Dry weight	kg 220

Dimensions Unit:mm

Engine only / Front view

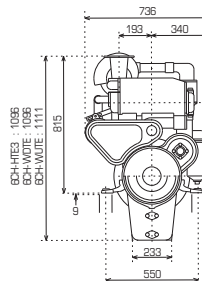

Engine only / Left side view

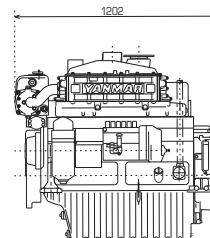

With gearbox / Front view

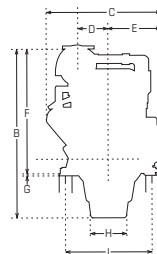

With gearbox / Left side view

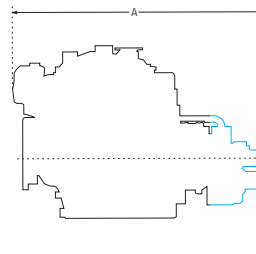

	A	B	C	D	E	F	G	H	I
6CH-HTE3 × YX-71	1600	1096	736	193	340	815	9	233	550
6CH-WUTE × YX-71	1600	1111	736	193	340	815	9	233	550

— Marine gear

Performance curves

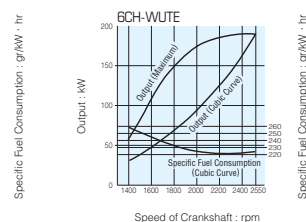
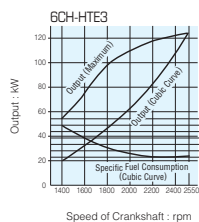

6CXBM-GT

H-rating 265kW (360mhp)
M-rating 294kW (400mhp)

MARINE
 PROPULSION
 DIESEL ENGINE



- 6-cylinder, direct injection, heat exchanger cooling.
- Turbocharger + intercooler.
- Available either with marine gear or without marine gear.
- 4-valves per cylinder for higher combustion efficiency.
- Conform to IMO Tier II emissions regulations.

Specifications

Model	6CXBM-GT	
Number of cylinders	6 in-line	
Bore × stroke	mm 110 × 130	
Displacement	lit. 7.413	
Rated output	kW(hp)/rpm H : 265(360)/2400 M : 294(400)/2500	
Combustion system	Direct injection	
Aspiration	Turbocharger + intercooler	
Starting system	Electric starting motor (24V 5.0kW)	
Cooling system	Heat exchanger	
Size of flywheel housing and flywheel	SAE #3 and 11-1/2 in.	
Dry mass (without marine gear)	kg 856	
Dimensions (L×W×H)	mm 1390×901×989	

Marine gear specifications

Engine model : 6CXBM-GT			
Model	YX-75	YXH2-130(2 speed type)	
Type	Hydraulic multi-disc clutch, wet type		
Reduction ratio (Ahead)	2.07 2.58 2.91	2.03/2.62 2.57/3.35 3.04/4.00	
Direction of rotation (propeller shaft)	Clockwise or counter-clockwise viewed from stern		Counter-clockwise viewed from stern
Dry weight	kg 204	320	

Dimensions Unit:mm

Engine only / Front view

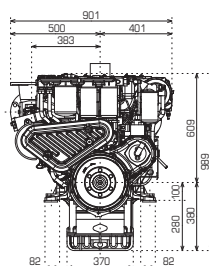

Engine only / Right side view

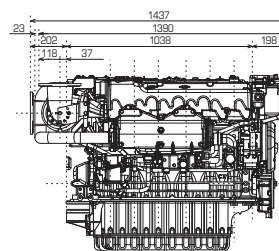

With YX75 gearbox / Rear view

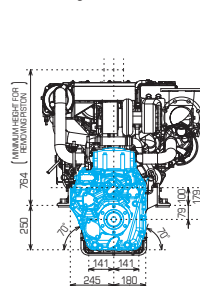

With YX75 gearbox / Right side view

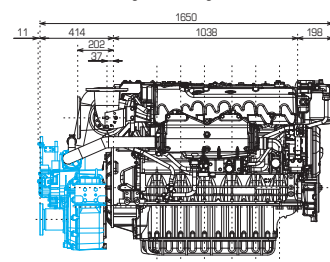

— Marine gear

Performance curves

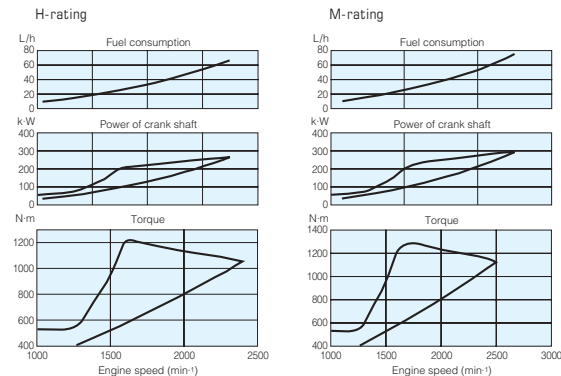

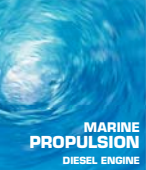

6CXBM-GT

L-rating 341kW (464mhp)
S-rating 374kW (509mhp) (For planing hull)



- 6-cylinder, direct injection, heat exchanger cooling.
- Turbocharger + intercooler.
- Available either with marine gear or without marine gear.
- 4-valves per cylinder for higher combustion efficiency.
- Conform to IMO Tier II emissions regulations.

Specifications

Model	6CXBM-GT		
Number of cylinders	6 in-line		
Bore × stroke	mm	110 × 130	
Displacement	lit.	7.413	
Rated output	kW(hp)/rpm	L : 341(464)/2700	
		S : 374(509)/2700	
Combustion system	Direct injection		
Aspiration	Turbocharger + intercooler		
Starting system	Electric starting motor (24V 5.0kW)		
Cooling system	Heat exchanger		
Size of flywheel housing and flywheel	SAE #3 and 11-1/2 in.		
Dry mass (without marine gear)	kg	856	
Dimensions (L×W×H)	mm	1390×901×989	

Marine gear specifications

Engine model : 6CXBM-GT			
Model	YX-75		
Type	Hydraulic multi-disc clutch, wet type		
Reduction ratio (Ahead)	2.07	2.58	2.91
Direction of rotation (propeller shaft)	Clockwise or counter-clockwise viewed from stern		
Dry weight	kg	204	

Dimensions Unit:mm

with optional shallow oil sump

Engine only / Front view

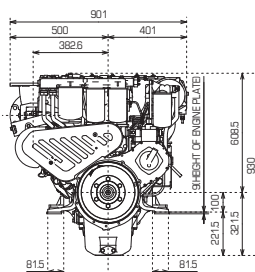

Engine only / Left side view

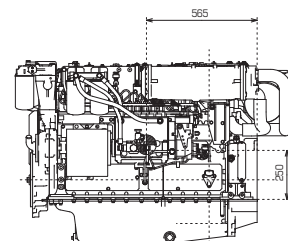

Engine only / Rear view

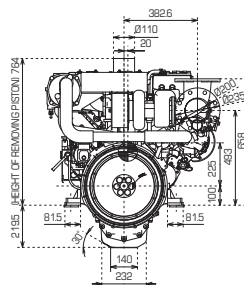

Engine only / Right side view

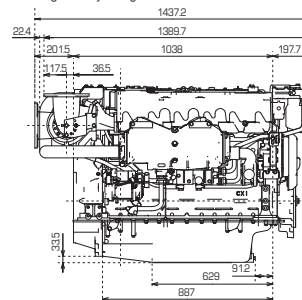

Performance curves

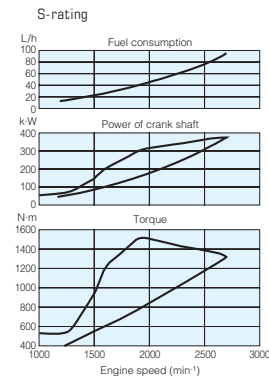
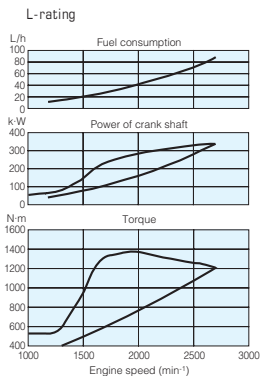



6HA2M-WHT

H-rating 204kW (278mhp)



- 6-cylinder, direct injection, heat exchanger cooling.
- Turbocharger + intercooler models.
- Available either with marine gear or without marine gear.
- Conform to IMO Tier II emissions regulations.

Specifications

Model	6HA2M-WHT	
Number of cylinders	6 in-line	
Bore × stroke	mm	130 × 165
Displacement	lit.	13.140
Rated output	kW(hp)/rpm	H : 204(278)/1880
Combustion system	Direct injection	
Aspiration	Turbocharger + intercooler	
Starting system	Electric starting motor (24V 6.0kW)	
Cooling system	Heat exchanger	
Size of flywheel housing and flywheel	SAE # 1 and 14 in.	
Dry mass (without marine gear)	kg	1455
Dimensions (L × W × H)	mm	1585 × 1016 × 1260

Marine gear specifications

Engine model : 6HA2M-WHT		
Model	YX120	YX120L
Type	Hydraulic multi-disc clutch	
Reduction ratio (Ahead)	2.03 2.57 3.04 3.55	4.00 4.59
Direction of rotation (propeller shaft)	Clockwise or counterclockwise	
Dry weight	kg	315 411

Dimensions Unit:mm

Engine only / Front view

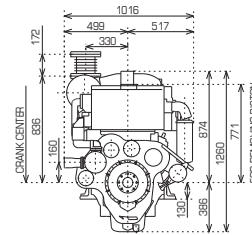

Engine only / Right side view

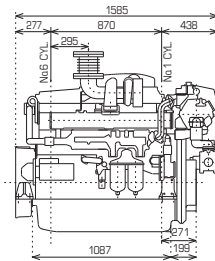

With YX120L gearbox / Front view

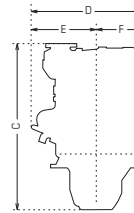

With YX120L gearbox / Left side view

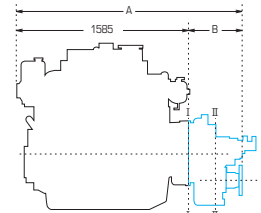

Model	A	B	C	D	E	F
6HA2M-WHT × YX-120	2005	420	1272	1016	499	517
6HA2M-WHT × YX-120L	2039	454	1384	1016	499	517

— Marine gear

Performance curves

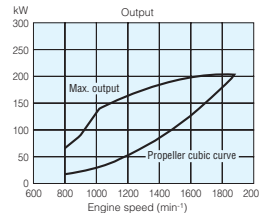
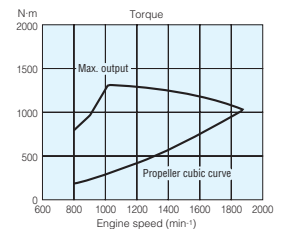
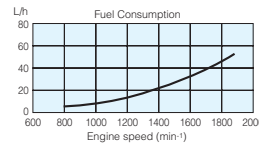

6HA2M-WHT

M-rating 257kW (350mhp)

MARINE
PROPULSION
DIESEL ENGINE



- 6-cylinder, direct injection, heat exchanger cooling.
- Turbocharger + intercooler models.
- Available either with marine gear or without marine gear.
- Conform to IMO Tier II emissions regulations.

Specifications

Model	6HA2M-WHT		
Number of cylinders	6 in-line		
Bore × stroke	mm	130 × 165	
Displacement	lit.	13140	
Rated output	kW(hp)/rpm	M: 257(350)/1950	
Combustion system	Direct injection		
Aspiration	Turbocharger + intercooler		
Starting system	Electric starting motor (24V 6.0kW)		
Cooling system	Heat exchanger		
Size of flywheel housing and flywheel	SAE #1 and 14 in.		
Dry mass (without marine gear)	kg	1455	
Dimensions (L×W×H)	mm	1585×1016×1260	

Marine gear specifications

Engine model : 6HA2M-WHT			
Model	YX120	YX120L	
Type	Hydraulic multi-disc clutch		
Reduction ratio (Ahead)	2.03	2.57	3.04 3.55
Direction of rotation (propeller shaft)	Clockwise or counterclockwise		
Dry weight	kg	315	411

Dimensions Unit:mm

Engine only / Front view

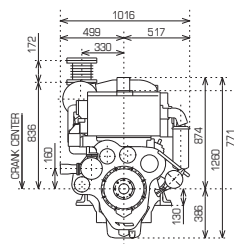

Engine only / Right side view

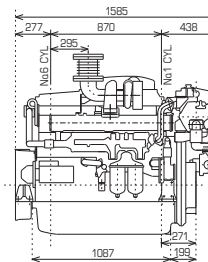

With YX120 gearbox / Front view

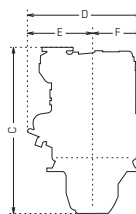

With YX120 gearbox / Left side view

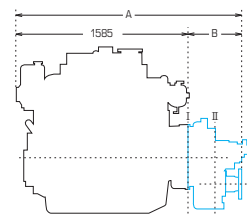

	A	B	C	D	E	F
6HA2M-WHT×YX-120	2005	420	1272	1016	499	517
6HA2M-WHT×YX-120L	2039	454	1384	1016	499	517

— Marine gear

Performance curves

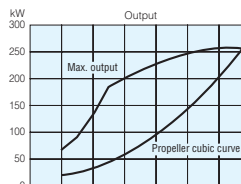
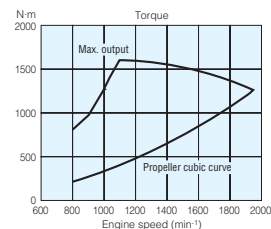
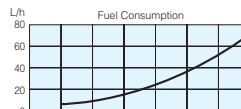

6HA2M-WDT

M-rating 298kW (405mhp)

MARINE
PROPULSION
DIESEL ENGINE



- 4 valves per cylinder for higher combustion efficiency.
- Turbocharger + intercooler models.
- Available either with marine gear or without marine gear.
- Conform to IMO Tier II emissions regulations.

Specifications

Model		6HA2M-WDT
Number of cylinders		6 in-line
Bore × stroke	mm	130 × 165
Displacement	lit.	13.140
Rated output	kW(hp)/rpm	M: 298(405)/1950
Combustion system		Direct injection
Aspiration		Turbocharger + intercooler
Starting system		Electric starting motor (24V 6.0kW)
Cooling system		Heat exchanger
Size of flywheel housing and flywheel		SAE # 1 and 14 in.
Dry mass (without marine gear)	kg	1465
Dimensions (L×W×H)	mm	1586×1037×1260

Marine gear specifications

Engine model : 6HA2M-WDT		
Model	YX-120	YX-120L
Type	Hydraulic multi-disc clutch	
Reduction ratio (Ahead)	2.03	2.57 3.04 4.00 4.59
Direction of rotation (propeller shaft)	Clockwise or counterclockwise	
Dry weight	kg	315 411

Dimensions Unit:mm

Engine only / Front view

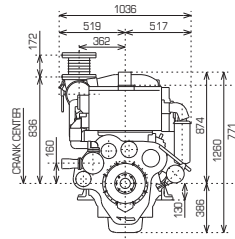

Engine only / Left side view

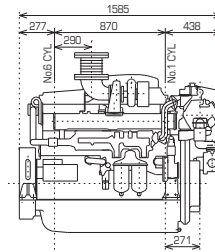

With YX120 gearbox / Front view

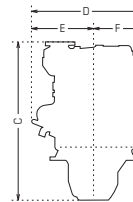

With YX120 gearbox / Left side view

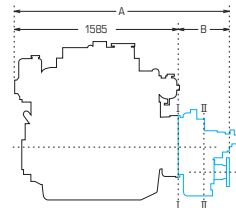

	A	B	C	D	E	F
6HA2M-WDT×YX-120	2005	420	1272	1036	519	517
6HA2M-WDT×YX-120L	2039	454	1384	1036	519	517

— Marine gear

Performance curves

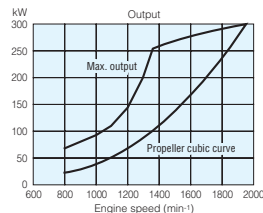
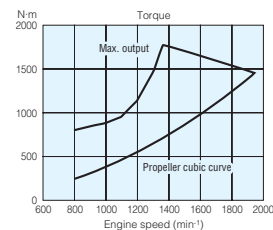
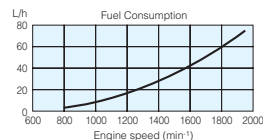

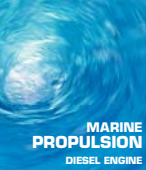

6HYM-WET

H-rating 368kW (500hp)

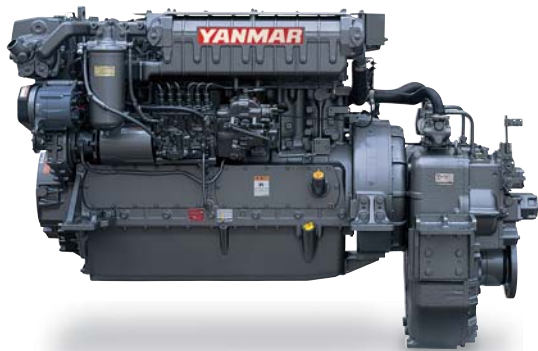

- 6-cylinder, direct injection, heat exchanger cooling.
- Twin-turbocharger + intercooler.
- Available either with marine gear or without marine gear.
- 4-valves per cylinder for higher combustion efficiency.
- Conform to IMO Tier II emissions regulations.

Specifications

Model	6HYM-WET H-rating		
Number of cylinders	6 in-line		
Bore × stroke	mm	132.9 × 165	
Displacement	lit.	13.733	
Rated output	kWhp/rpm	368(500)/1950	
Combustion system	Direct injection		
Aspiration	Turbocharger + intercooler		
Starting system	Electric starting motor (24V 6.0kW)		
Cooling system	Heat exchanger		
Size of flywheel housing and flywheel	SAE # 1 and 14 in.		
Dry mass	kg	1385(without marine gear)	
Dimensions (L×W×H)	mm	1556×1014×1133	

Marine gear specifications

Engine model : 6HYM-WET H-rating						
Model	YXH460	YX161L				
Type	Hydraulic multi-disc clutch					
Reduction ratio (Ahead)	1.97	2.46	3.05	3.65	4.08	4.55
Direction of rotation (propeller shaft)	Clockwise or counterclockwise					
Dry weight	kg	390	620			

Dimensions Unit:mm

Engine only / Front view

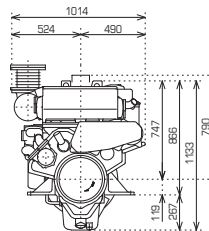

Engine only / Right side view

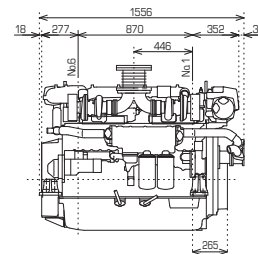

With YX161L gearbox / Rear view

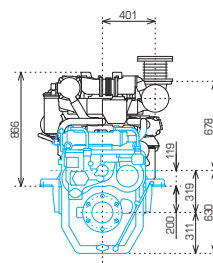

With YX161L gearbox / Right side view

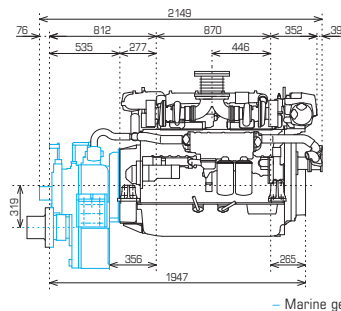

Performance curves

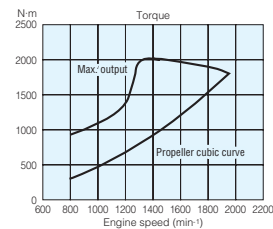
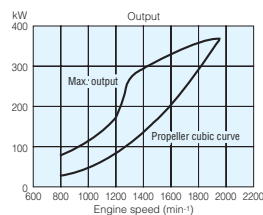
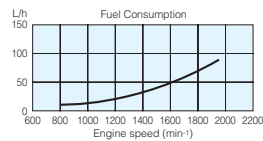

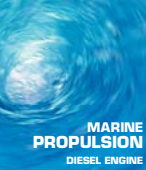

6HYM-WET

M-rating 441kW (600mhp)
L-rating 478kW (650mhp)



- 6-cylinder, direct injection, heat exchanger cooling.
- Twin-turbocharger + intercooler.
- Available either with marine gear or without marine gear.
- 4-valves per cylinder for higher combustion efficiency.
- Conform to IMO Tier II emissions regulations.

Specifications

Model	6HYM-WET M-rating / Lrating	
Number of cylinders	6 in-line	
Bore × stroke	mm	132.9 × 165
Displacement	lit.	13.733
Rated output	kWhp/rpm	M : 441(600)/2100
		L : 478(650)/2150
Combustion system	Direct injection	
Aspiration	Turbocharger + intercooler	
Starting system	Electric starting motor (24V 6.0kW)	
Cooling system	Heat exchanger	
Size of flywheel housing and flywheel	SAE #1 and 14 in.	
Dry mass	kg	1385(without marine gear)
Dimensions (L×W×H)	mm	1556 × 1014 × 1133

Marine gear specifications

Engine model : 6HYM-WET M-rating / Lrating						
Model	YXH160	YX161L				
Type	Hydraulic multi-disc clutch					
Reduction ratio (Ahead)	1.97	2.46	3.05	3.65	4.08	4.55
Direction of rotation (propeller shaft)	Clockwise or counterclockwise					
Dry weight	kg	390	620			

Dimensions Unit:mm

Engine only / Front view

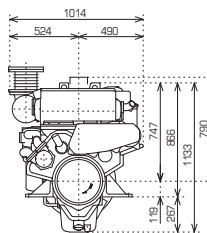

Engine only / Right side view

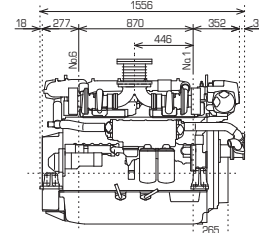

With YXH160 gearbox / Rear view

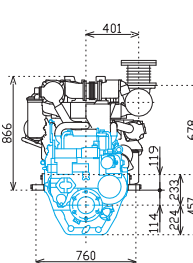

With YXH160 gearbox / Right side view

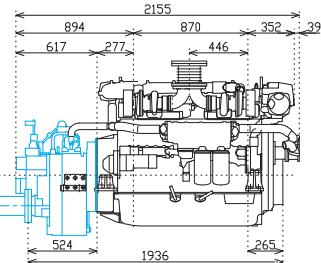

— Marine gear

Performance curves

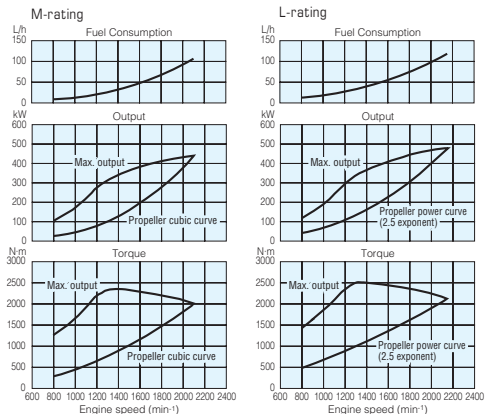

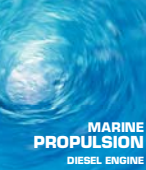

6HYM-WET

S-rating 515kW (700mhp)
(For planing hull)



- 6-cylinder, direct injection, heat exchanger cooling.
- Twin-turbocharger + intercooler.
- Available either with marine gear or without marine gear.
- 4-valves per cylinder for higher combustion efficiency.
- Conform to IMO Tier II emissions regulations.

Specifications

Model	6HYM-WET S-rating		
Number of cylinders	6 in-line		
Bore × stroke	mm	132.9 × 165	
Displacement	lit.	13.733	
Rated output	kW(hp)/rpm	515(700)/2200	
Combustion system	Direct injection		
Aspiration	Turbocharger + intercooler		
Starting system	Electric starting motor (24V 6.0kW)		
Cooling system	Heat exchanger		
Size of flywheel housing and flywheel	SAE # 1 and 14 in.		
Dry mass	kg	1385(without marine gear)	
Dimensions (L×W×H)	mm	1556×1014×1133	

Marine gear specifications

Engine model : 6HYM-WET S-rating			
Model	YXH160		
Type	Hydraulic multi-disc clutch		
Reduction ratio (Ahead)	1.97	2.46	3.05
Direction of rotation (propeller shaft)	Clockwise or counterclockwise		
Dry weight	kg	390	

Dimensions Unit:mm

Engine only / Front view

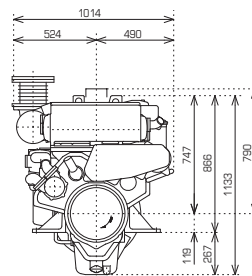

Engine only / Right side view

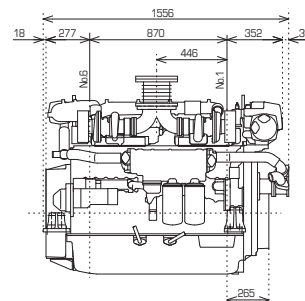

Engine only / Rear view

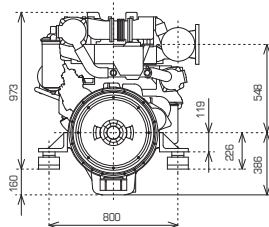

Engine only / Right side view

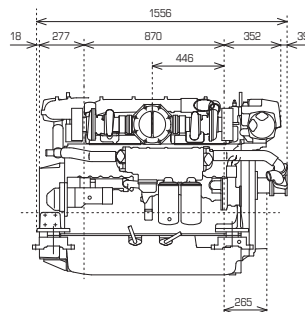

Performance curves

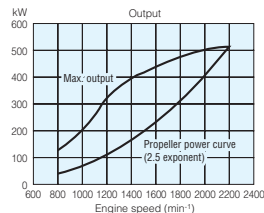
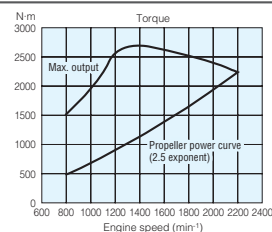
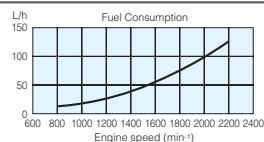

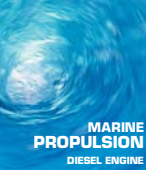

6AYM-WST

H-rating 485kW (659mhp)



- 6-cylinder, direct injection, heat exchanger cooling.
- Turbocharger + intercooler.
- 4-valves per cylinder for higher combustion efficiency.
- Available either with marine gear or without marine gear.
- Conform to IMO Tier II emissions regulations.

Specifications

Model	6AYM-WST H-rating		
Number of cylinders	6 in-line		
Bore × stroke	mm	155 × 180	
Displacement	lit.	20.379	
Rated output	kW(hp)/rpm	H : 485(659)/1900	
Combustion system	Direct injection		
Aspiration	Turbocharger + intercooler		
Starting system	Electric starting motor (24V 7.0kW)		
Cooling system	Heat exchanger		
Size of flywheel housing and flywheel	SAE #0 and 18 in.		
Dry mass	kg	2365 (without marine gear)	
Dimensions (L×W×H)	mm	2000×1305×1431	

Marine gear specifications

Engine model : 6AYM-WST H-rating				
Model	YX181	YX180L	YXH-240L	
Type	Hydraulic multi-disc clutch			
Reduction ratio (Ahead)	2.08 2.55 3.03	3.50 4.00 4.54	4.89 5.36 5.91 6.57 6.95	
Direction of rotation (propeller shaft)	Clockwise or counterclockwise			
Dry weight	kg	560	680	1240

Dimensions Unit:mm

With YX181 gearbox / Rear view

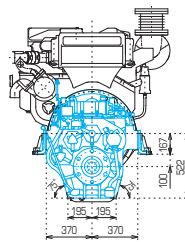

With YX181 gearbox / Right side view

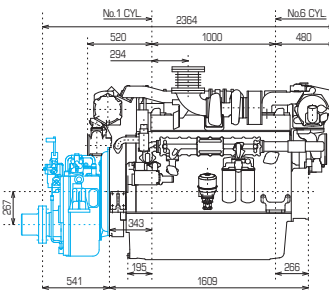

With YX180L gearbox / Rear view

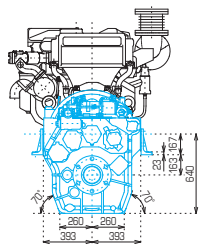

With YX180L gearbox / Right side view

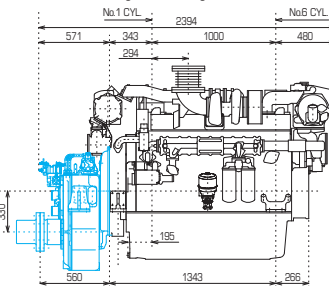

— Marine gear

Performance curves

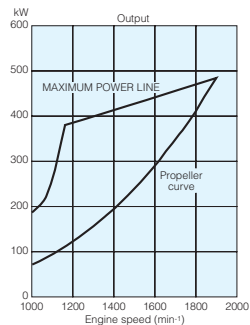
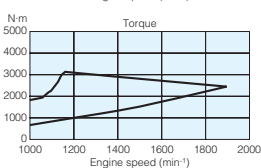
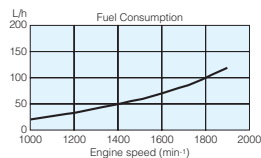

6AYM-WET

H-rating 555kW (755mhp)

MARINE
PROPULSION
DIESEL ENGINE



- 6-cylinder, direct injection, heat exchanger cooling.
- Turbocharger + intercooler.
- 4-valves per cylinder for higher combustion efficiency.
- Available either with marine gear or without marine gear.
- Conform to IMO Tier II emissions regulations.

Specifications

Model	6AYM-WET H-rating	
Number of cylinders	6 in-line	
Bore × stroke	mm	155 × 180
Displacement	lit.	20.379
Rated output	kW/hp/rpm	H : 555(755)/1840
Combustion system	Direct injection	
Aspiration	Turbocharger + intercooler	
Starting system	Electric starting motor (24V 7.0kW)	
Cooling system	Heat exchanger	
Size of flywheel housing and flywheel	SAE #0 and 18 in.	
Dry mass	kg	2365 (without marine gear)
Dimensions (L×W×H)	mm	2000×1305×1431

Marine gear specifications

Engine model : 6AYM-WET H-rating		
Model	YXH-240	YXH-240L
Type	Hydraulic multi-disc clutch	
Reduction ratio (Ahead)	1.95 2.27 2.56 3.03 3.48	4.89 5.36 5.91 6.57 6.95
Direction of rotation (propeller shaft)	Clockwise or counterclockwise	
Dry weight	kg	1240

Dimensions Unit:mm

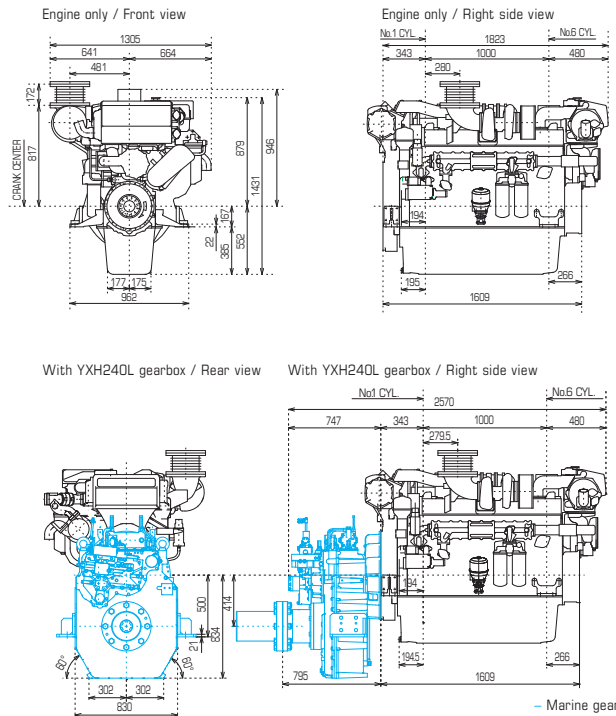

Performance curves

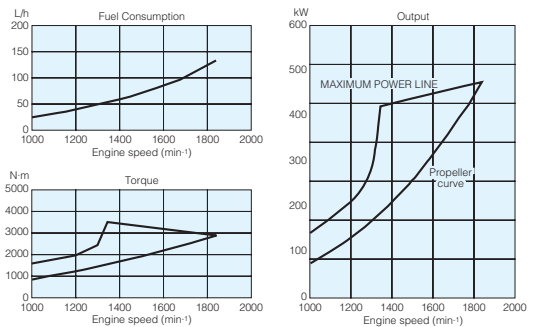

6AYM-WET

M-rating 610kW (829mhp)

MARINE
PROPULSION
DIESEL ENGINE



- 6-cylinder, direct injection, heat exchanger cooling.
- Turbocharger + intercooler.
- 4-valves per cylinder for higher combustion efficiency.
- Available either with marine gear or without marine gear.
- Conform to IMO Tier II emissions regulations.

Specifications

Model	6AYM-WET M-rating	
Number of cylinders	6 in-line	
Bore × stroke	mm	155 × 180
Displacement	lit.	20.379
Rated output	kWhp/lrpm	M : 610(829)/1900
Combustion system	Direct injection	
Aspiration	Turbocharger + intercooler	
Starting system	Electric starting motor (24V 7.0kW)	
Cooling system	Heat exchanger	
Size of flywheel housing and flywheel	SAE #0 and 18 in.	
Dry mass	kg	2365 (without marine gear)
Dimensions (L×W×H)	mm	2000×1305×1431

Marine gear specifications

Engine model : 6AYM-WET M-rating		
Model	YXH-240	YXH-240L
Type	Hydraulic multi-disc clutch	
Reduction ratio (Ahead)	1.95 2.27 2.56 3.03 348	4.89 5.36 5.91 6.57 6.95
Direction of rotation (propeller shaft)	Clockwise or counterclockwise	
Dry weight	kg	1240

Dimensions Unit:mm

Engine only / Front view

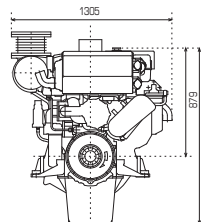

Engine only / Right side view

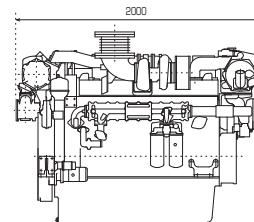

With YXH240 gearbox / Rear view

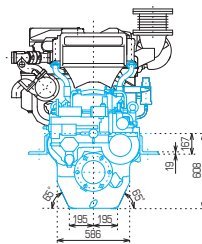

With YXH240 gearbox / Right side view

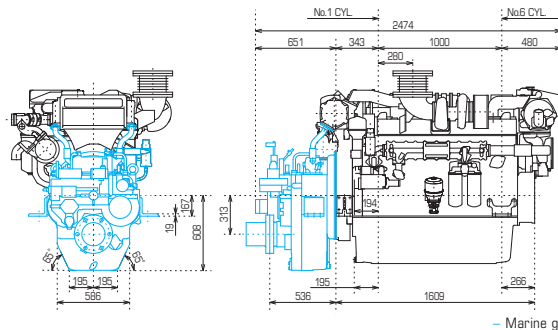

Performance curves

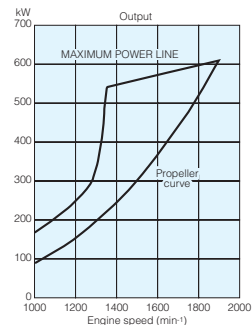
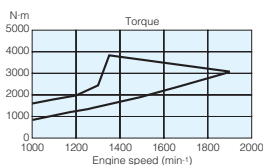
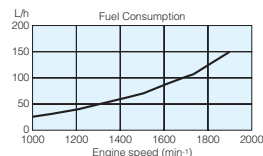

6AYM-WGT

L-rating 670kW (911mhp)

MARINE
PROPULSION
DIESEL ENGINE



- 6-cylinder, direct injection, heat exchanger cooling.
- Turbocharger + intercooler.
- 4-valves per cylinder for higher combustion efficiency.
- Available either with marine gear or without marine gear.
- Conform to IMO Tier II emissions regulations.

Specifications

Model	6AYM-WGT L-rating
Number of cylinders	6 in-line
Bore × stroke	mm 155 × 180
Displacement	lit. 20.379
Rated output	kW(hp)/rpm L : 670(911)/1938
Combustion system	Direct injection
Aspiration	Turbocharger + intercooler
Starting system	Electric starting motor (24V 7.0kW)
Cooling system	Heat exchanger
Size of flywheel housing and flywheel	SAE #0 and 18 in.
Dry mass	kg 2365 (without marine gear)
Dimensions (L×W×H)	mm 2000×1305×1431

Marine gear specifications

Engine model	6AYM-WGT L-rating				
Model	YXH-240				
Type	Hydraulic multi-disc clutch				
Reduction ratio (Ahead)	1.95	2.27	2.56	3.03	3.48
Direction of rotation (propeller shaft)	Clockwise or counterclockwise				
Dry weight	kg	645			

Dimensions Unit:mm

Engine only / Front view

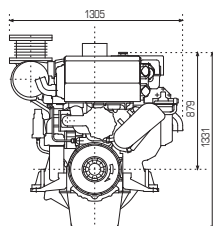

Engine only / Right side view (Shallow sump)

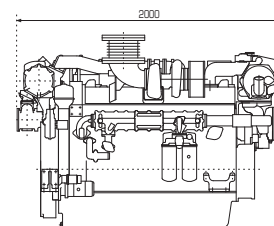

With YXH240 gearbox / Rear view

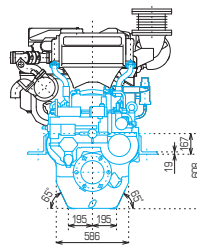

With YXH240 gearbox / Right side view

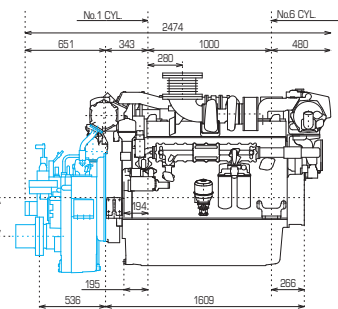

— Marine gear

Performance curves

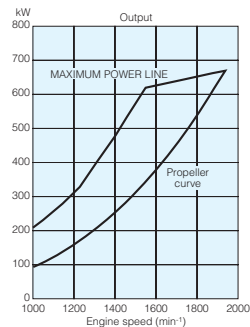
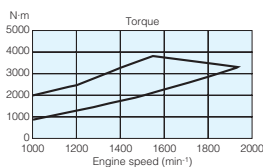
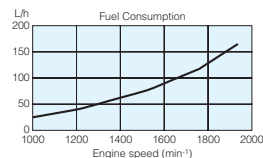

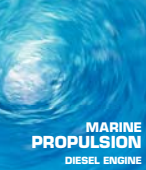

12AYM-WST

H-rating 882kW (1200mhp)
H-rating 1030kW (1400mhp)



- V-type, 12-cylinder, direct injection, heat exchanger cooling.
- Turbocharger + intercooler.
- 4-valves per cylinder for higher combustion efficiency.
- Conform to IMO Tier II emissions regulations.

Specifications

Model	12AYM-WST H-rating
Number of cylinders	12 V-type
Bore × stroke	mm 155 × 180
Displacement	lit. 40.76
Rated output	kW/hp/rpm H : 882(1200)/1850 H : 1030(1400)/1900
Combustion system	Direct injection
Aspiration	Turbocharger + intercooler
Starting system	Electric starting motor (24V-6.5kW)×2 or air motor×2
Cooling system	Constant high temperature cooling system
Size of flywheel housing and flywheel	SAE #00 and 21 in.
Dry mass	kg 4870 (without Fresh water cooler)
Dimensions (L×W×H)	mm 2615 × 1645 × 1708

Dimensions Unit:mm

Engine only / Front view

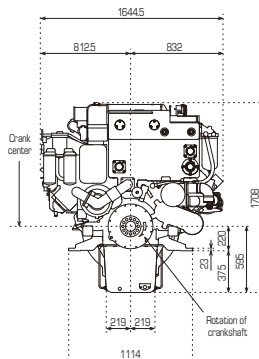

Engine only / Right side view

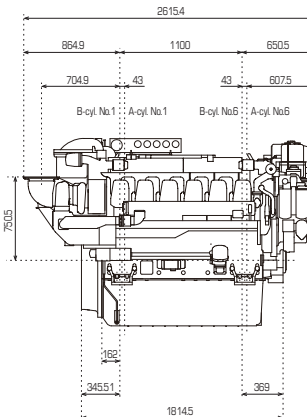

Performance curves

H rating 882kW (1200mhp)

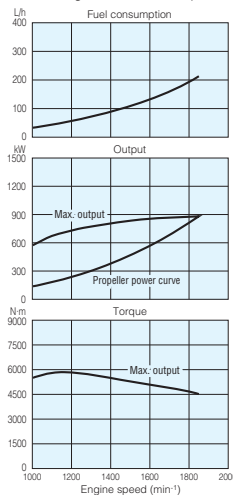

H rating 1030kW (1400mhp)

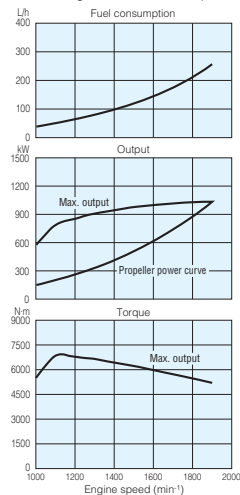

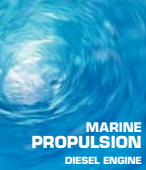

12AYM-WET

H-rating 1140kW (1550mhp)

M-rating 1220kW (1659mhp)



- V-type, 12-cylinder, direct injection, heat exchanger cooling.
- Turbocharger + intercooler.
- 4-valves per cylinder for higher combustion efficiency.
- Conform to IMO Tier II emissions regulations.

Specifications

Model	12AYM-WET H-rating / M-rating
Number of cylinders	12 V-type
Bore × stroke	mm 155 × 180
Displacement	lit. 40.76
Rated output	kW/hp/rpm H : 1140(1550)/1840 M : 1220(1659)/1900
Combustion system	Direct injection
Aspiration	Turbocharger + intercooler
Starting system	Electric starting motor (24V-6.5kW)×2 or air motor×2
Cooling system	Constant high temperature cooling system
Size of flywheel housing and flywheel	SAE #00 and 21 in.
Dry mass	kg 4870 (without Fresh water cooler)
Dimensions (L×W×H)	mm 2615 × 1645 × 1708

Dimensions Unit:mm

Engine only / Front view

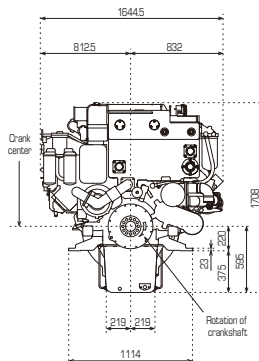

Engine only / Right side view

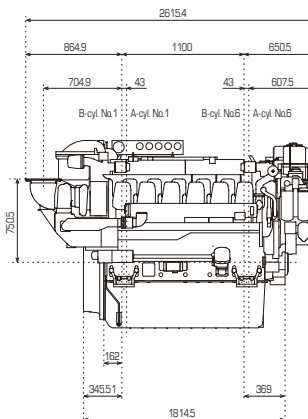

Performance curves

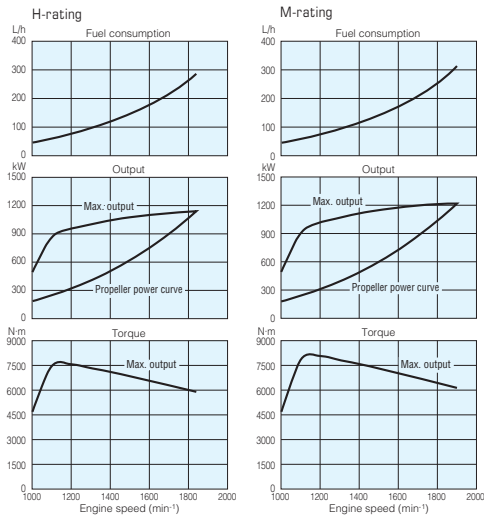

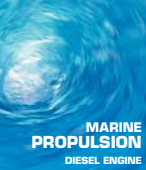

12AYM-WGT

L-rating 1340kW (1822mhp)



- V-type, 12-cylinder, direct injection, heat exchanger cooling.
- Turbocharger + intercooler.
- 4-valves per cylinder for higher combustion efficiency.
- Conform to IMO Tier II emissions regulations.

Specifications

Model	12AYM-WGT L-rating
Number of cylinders	12 V-type
Bore × stroke	mm 155 × 180
Displacement	lit. 40.76
Rated output	kW(hp)/rpm L : 1340(1822)/1940
Combustion system	Direct injection
Aspiration	Turbocharger + intercooler
Starting system	Electric starting motor (24V-6.5kW)×2 or air motor×2
Cooling system	Constant high temperature cooling system
Size of flywheel housing and flywheel	SAE #00 and 21 in.
Dry mass	kg 4870 (without Fresh water cooler)
Dimensions (L×W×H)	mm 2615×1645×1708

Dimensions Unit:mm

Engine only / Front view

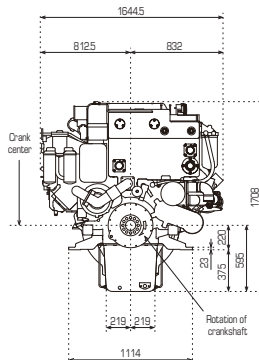

Engine only / Right side view

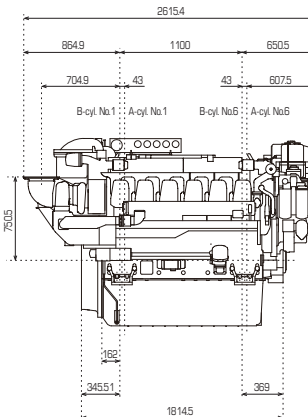

Performance curves

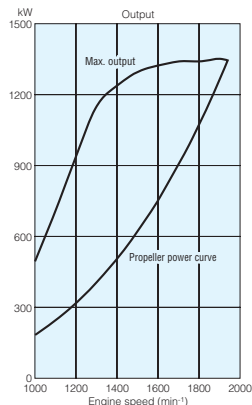
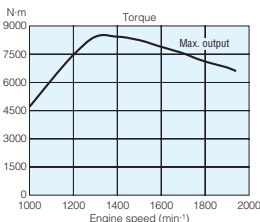
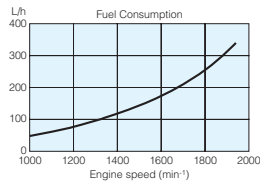

4CHL series

MARINE
AUXILIARY
DIESEL ENGINE

38~74hp / 1500~1800rpm
30~60kVA (24~48kW)

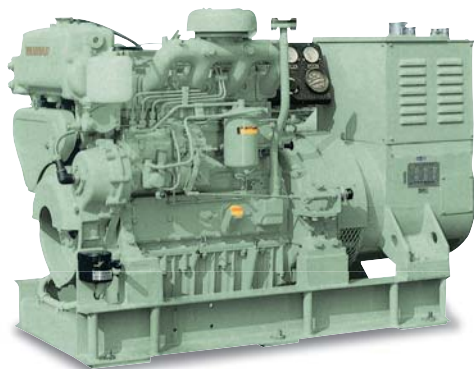

- 4-cylinder, direct injection.
- Natural aspirated or turbocharged.

Specifications

TNA is not Type approved.

Model	4CHL-N	4CHL-TN	4CHL-TNA
Number of cylinders	In-line 4		
Bore × stroke	mm 105 × 125		
Displacement	lit. 4.33		
Continuous rated engine speed	rpm 1500 1800	1500 1800	1500 1800
Continuous rated output	hp 38 50	50 62	62 74
Applicable generator capacity	kVA(kW) 30 40 (24) (32)	40 50 (32) (40)	50 60 (40) (48)
Frequency	Hz 50 60	50 60	50 60
Combustion system	Direct injection		
Aspiration	Natural aspiration	Exhaust Turbocharger	
Dry weight (Engine only)	kg 500	520	520
Dry weight (Gen. set)	kg 990	1040	1090

Dimensions Unit:mm

Engine only (4CHL-TN)

Front view

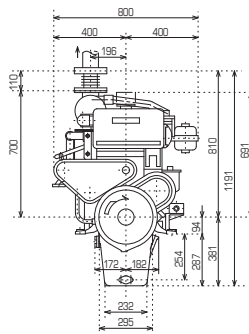

Left side view

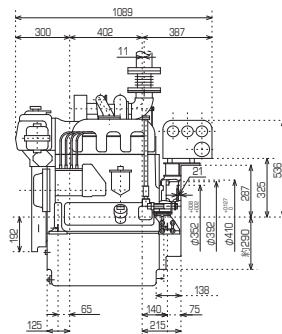

Generator set dimensions for your reference Unit:mm

Generator set dimensions shown below depend on generator model

Front view

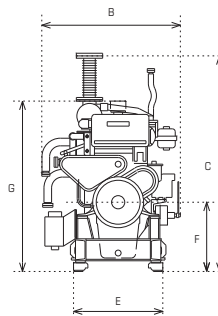

Left side view

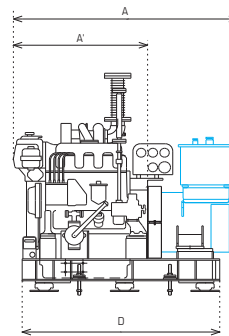

Model	A	A'	B	C	D	E	F	G
4CHL-N	1552	917	947	1351	1350	610	473	1164
4CHL-TN	1532	917	947	1173	1350	610	473	1164
4CHL-TNA	1572	917	947	1173	1420	610	473	1164

— Generator

6CHL series

MARINE
AUXILIARY
DIESEL ENGINE

62~145hp/1500~1800rpm
50~120kVA (40~96kW)



- 6-cylinder, direct injection.
- Natural aspirated or turbocharged.

Specifications

TNA is not Type approved by BV.
HTN(A) is not Type approved.

Model	6CHL-N	6CHL-TN	6CHL-TNA	6CHL-HTN	6CHL-HTNA
Number of cylinders	In-line 6				
Bore × stroke	mm 105 × 125				
Displacement	lit. 6.494				
Continuous rated engine speed	1500 1800	1500 1800	1500 1800	1500 1800	1500 1800
Continuous rated output	62 74	74 100	92 122	100 120	125 145
Applicable generator capacity	50 60 (40) (48)	60 80 (48) (64)	75 100 (60) (80)	80 100 (64) (80)	100 120 (80) (96)
Frequency	50 60	50 60	50 60	50 60	50 60
Combustion system	Direct injection				
Aspiration	Natural aspiration	Exhaust Turbocharger	Exhaust Turbocharger with intercooler		
Dry weight (Engine only)	625	645	645	675	675
Dry weight (Gen. set)	1220	1350	1350	1380	1540

Dimensions Unit:mm

Engine only (6CHL-HTN)

Front view

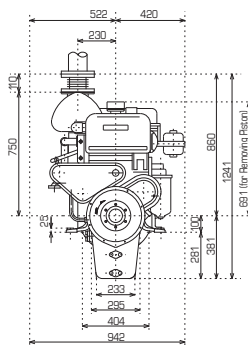

Left side view

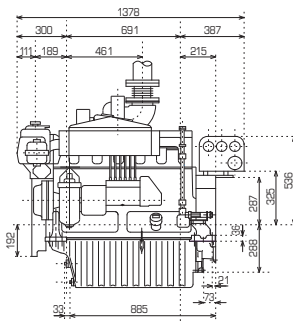

Generator set dimensions for your reference Unit:mm

Generator set dimensions shown below depend on generator model

Front view

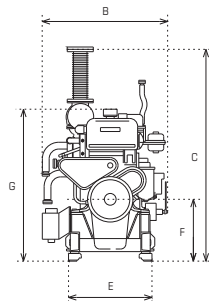

Left side view

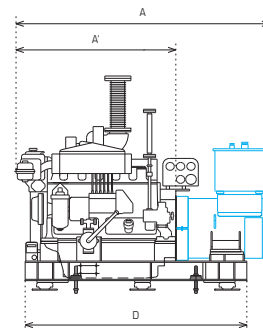

G : Minimum Height for Removing Piston (Not included the dimension for bolt fitting to piston remove.)

Model	A	A'	B	C	D	E	F	G
6CHL-N	1861	1206	962	1382	1650	640	474	1165
6CHL-TN	1926	1206	962	1624	1700	640	474	1165
6CHL-TNA	1926	1206	962	1624	1700	640	474	1165
6CHL-HTN	1946	1256	962	1624	1700	640	474	1165
6CHL-HTNA	2051	1256	962	1634	1900	640	484	1175

— Generator

4HAL2 series

MARINE
AUXILIARY
DIESEL ENGINE

98~183hp / 1200~1800rpm
80~150kVA (64~120kW)

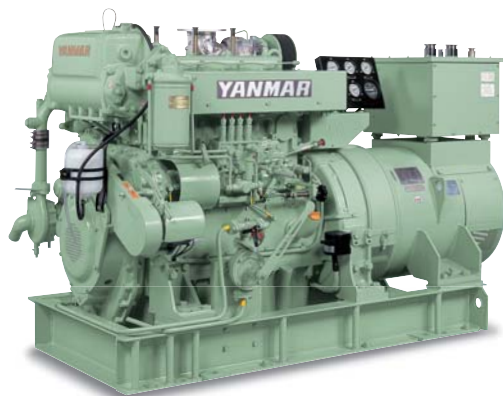

- 4-cylinder, direct injection.
- 4HAL2-WT Conform to IMO Tier II emissions regulations.

Specifications

Model	4HAL2-TN1	4HAL2-TN	4HAL2-WT
Number of cylinders	In-line 4		
Bore × stroke	mm 130 × 165		
Displacement	lit. 8.76		
Continuous rated engine speed	rpm 1200 1500 1800	1200 1500	1800
Continuous rated output	hp 98 121 157	122 156	183
Applicable generator capacity	kVA(kW) 80 100 130 (64) (80) (104)	100 125 (80) (100)	150 (120)
Frequency	Hz 60 50 60	60 50	60
Combustion system	Direct injection		
Aspiration	Exhaust Turbocharger		
Dry weight (Engine only)	kg 1030		
Dry weight (Gne. set)	kg 1855		

Dimensions Unit:mm

Engine only

Front view

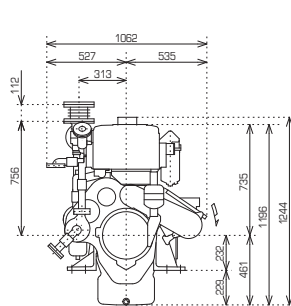

Left side view

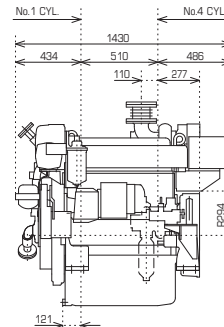

Generator set dimensions for your reference Unit:mm

Generator set dimensions shown below depend on generator model

Front view

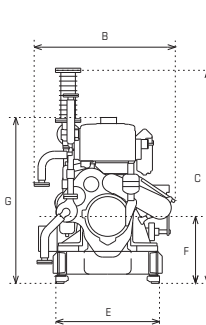

Left side view

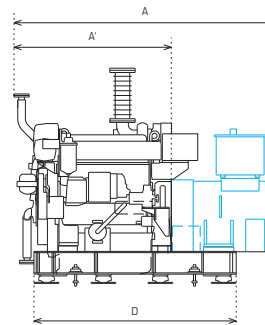

G : Minimum Height for Removing Piston (Not included the dimension for bolt fitting to piston remove)

Model	A	A'	B	C	D	E	F	G
4HAL2-TN1	2070	1245	1117	1685	1600	820	529	1312
4HAL2-TN	2070	1245	1117	1685	1600	820	529	1312
4HAL2-WT	2070	1245	1117	1685	1600	820	529	1312

— Generator

6HAL2 series

MARINE
AUXILIARY
DIESEL ENGINE

122~414hp / 1200~1800rpm
100~350kVA (80~280kW)



- 6-cylinder, direct injection.
- Natural aspirated or turbocharged. (with intercooler)
- 6HAL2-WT, 6HAL2-WHT and 6HAL2-WDT conform to IMO Tier II emissions regulations.

Specifications

Model	6HAL2-N	6HAL2-TN	6HAL2-WT	6HAL2-WHT	6HAL2-WDT
Number of cylinders	In-line 6				
Bore × stroke	mm 130 × 165				
Displacement	lit. 13.14				
Continuous rated engine speed	1200 1500	1200	1500 1800	1200 1500 1800	1200 1500 1800
Continuous rated output	122 156	163	204 244	217 299 360	271 346 414
Applicable generator capacity	100 125 (80) (100)	130 (104)	170 200 (136) (160)	180 250 300 (144) (200) (240)	225 290 350 (180) (232) (280)
Frequency	60 50	60	50 60	60 50 60	60 50 60
Combustion system	Direct injection				
Aspiration	Natural aspiration	Exhaust Turbocharger	Exhaust Turbocharger with intercooler		
Dry weight (Engine only)	1380	1422	1437	1447	
Dry weight (Gen. set)	2360	2410	2750	2850	

Dimensions Unit:mm

Engine only (6HAL2-TN, -WT, -WHT, -WDT)

Front view

Left side view

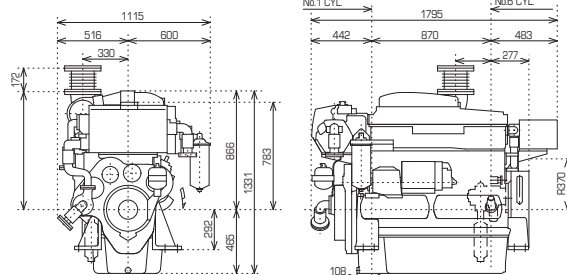

Generator set dimensions for your reference Unit:mm

Generator set dimensions shown below depend on generator model

Front view

Left side view

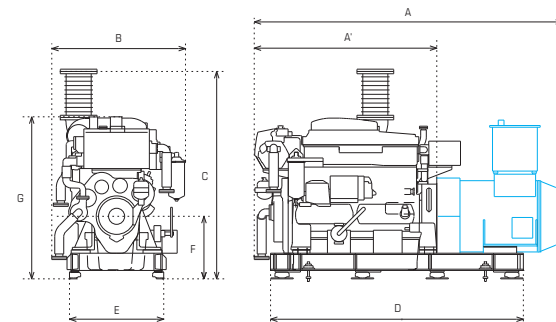

G : Minimum Height for Removing Piston (No: included the dimension for bolt fitting to piston remove.)

Model	A	A'	B	C	D	E	F	G
6HAL2-N	2499	1589	1164	1654	2100	820	544	1327
6HAL2-TN	2499	1589	1164	1774	2100	820	544	1327
6HAL2-WT	2499	1589	1164	1774	2100	820	544	1327
6HAL2-WHT	2574	1589	1164	1804	2200	820	544	1327
6HAL2-WDT	2684	1589	1164	1804	2200	820	544	1327

— Generator

6AYL series

MARINE
AUXILIARY
DIESEL ENGINE

480~668hp / 1500~1800rpm
400~562.5kVA (320~450kW)



- 6-cylinder, direct injection.
- Turbocharged with intercooler.
- Conform to IMO Tier II emissions regulations.

Specifications

Model	6AYL-WST	6AYL-WET	
Number of cylinders	In-line 6		
Bore × stroke	mm	155 × 180	
Displacement	lit.	20.379	
Continuous rated engine speed	rpm	1800	1500 1800
Continuous rated output	hp	480	596 668
Applicable generator capacity	kVA(kW)	400(320)	500(400) 562.5(450)
Frequency	Hz	60	50 60
Combustion system	Direct injection		
Aspiration	Exhaust Turbocharger with intercooler		
Dry weight (Engine only)	kg	2475	
Dry weight (Gen. set)	kg	4600	4750

Dimensions Unit:mm

Engine only

Front view

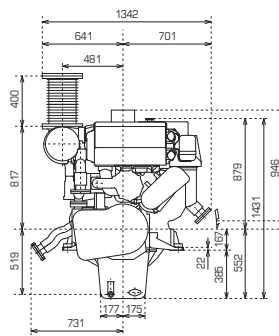

Left side view

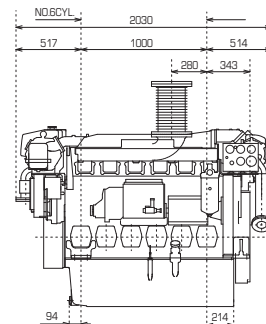

Generator set dimensions for your reference Unit:mm

Generator set dimensions shown below depend on generator model

Front view

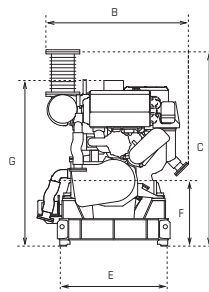

Left side view

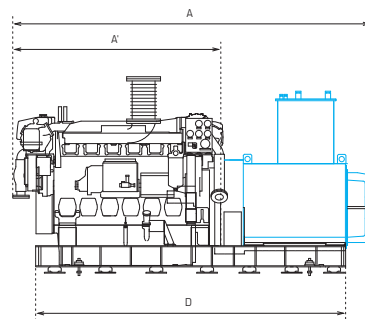

G : Minimum Height for Removing Piston (Not included the dimension for bolt fitting to piston remove.)

Model	A	A'	B	C	D	E	F	G
6AYL-WST	2970	1860	1445	1836	2540	1030	619	1565
6AYL-WET	3040	1860	1445	1836	2600	1030	619	1565

— Generator

Notes

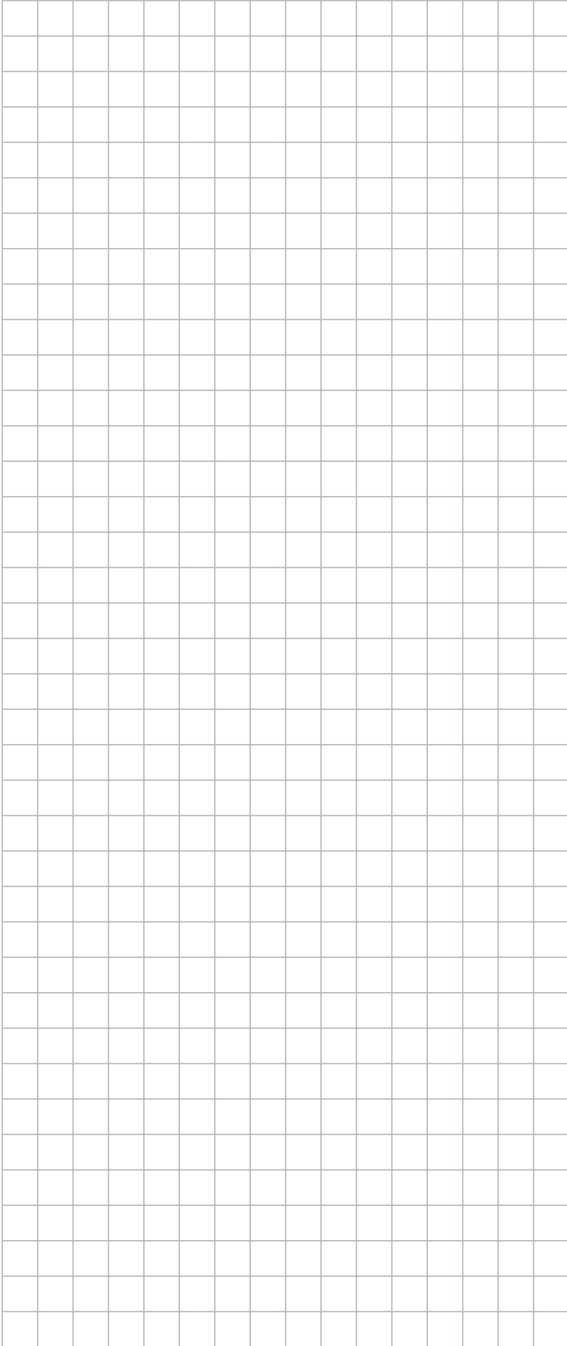

Notes

